

# A new method to glue the sole of rubber slippers with complicated surfaces

Tung Thanh Luu\*

## ABSTRACT

Nowadays, people often wear shoes or slippers when going outside. Rubber slippers are very popular in the world, especially in tourist area. Rubber slippers can be easily seen at tropical countries such as Vietnam. A slipper consists of many layers, and they are glued and then pressed to ensure them not to be separated during retention period. In the past, the layers of slippers is glued by rollers because the surfaces of layers are flat and simple. However, the slippers are now improved and then the surfaces of layers become complicated and difficult to spread the glue. The surface is produced by curved faces matching with the foot. Therefore, the workers have to use a brush to spread the glue on the surfaces, especially the line of intersection of surfaces. The rollers are tried but the result is so bad because the glue cannot reach the intersection of two faces on the surface of the slipper. The places without the glue will make the slipper become failure after used. In this paper, although the rollers are also applied, the rotational speed of these rollers are different. The different speed helps the glue spread to be same as glued by hand. The number of rollers is determined by experiment. The ratio of rotational speed and the gap between two rollers are also showed by experiment to obtain a best result of the glue spread. All of the experimental data will be shown by graphs helping the readers to understand more clearly about the best parameters for machine operation. Results from this paper are foundation for designing a real gluing machine which helps shoe manufacturing industry to develop.

**Key words:** rubber slipper, glue spread, rotational speed, different speed, roller

## INTRODUCTION

The rubber slippers are nowadays very popular with us. They can be seen on the beaches, on the streets and at home. Many millions of pairs of slippers are everyday made. Thus, automation is required to apply for manufacturing rubber slippers. Last time, the structure of the rubber slippers are simple, they only consists of rubber layers stuck by glue. The layers are flat and glue spread is automated by using rollers. The principle of glue is very simple (Figure 1), there are 2 main rollers, one supplies the glue to the other and the other spread the glue to the surface of the slipper<sup>1</sup>.

The fashion is one of industrial field changing very fast. The rubber slipper is not out of this rule. Style and model change so fast and as a result the surfaces of layers is not flat and they are designed with curved surfaces. Thus, the line of intersection of surfaces appear, that make the glue not be able to reach this line and therefore, the layers are easy to be peeled. Because of this, a lots of workers are recruited for glue spread on the surfaces of layers. To solve this problem, many patents are recognized.

E. A. Petersen invented a new method to glue papers discontinuously<sup>2</sup>. There are some places on the paper needing to be glued, therefore, the roller requires

to spread glue on some areas only. The roller in the invention can rotate or stop by a mechanical control system. The good solution is to glue different areas on the article however the invention can only apply for the flat area.

E. A. Petersen's invention is only applied for adhesive strip perpendicular to movement of paper. In some case, the strip of glue is required parallel to movement of article. In this case, C. F. Shaefer invented a machine with roller which includes rings being able rotate independently<sup>3</sup>. The papers move on the face 10 (Figure 2). These rings will move when cams 68 contact electrical buttons. Here, the cam 64 will raise or lower the glue tank 70 and then the glue spread on the paper when the glue tank is at the lowest position. The rule of contact is designed with rule of glue spread on the article.

When articles have slots or lines of intersection of surfaces, the said principle cannot ensure the glue will spread all surface. Another inventor Julius M. Steinberg<sup>4</sup> invent a new method to spread glue. The glue is sprayed on the surface by nozzles. The principle of the new creation is displayed in Figure 3. After the article is sprayed, the glue is spread on the surface by rollers. This invention solved the problem of glue spread on

Ho Chi Minh city University of Technology, VNU-HCM

### Correspondence

Tung Thanh Luu, Ho Chi Minh city University of Technology, VNU-HCM

Email: ttluu@hcmut.edu.vn

### History

- Received: 21-6-2018
- Accepted: 02-5-2019
- Published: 25-5-2019

### DOI :



### Copyright

© VNU-HCM Press. This is an open-access article distributed under the terms of the Creative Commons Attribution 4.0 International license.



**Cite this article :** Luu T.T. A new method to glue the sole of rubber slippers with complicated surfaces. *Sci. Tech. Dev. J. – Engineering and Technology*; 2(1):1-10.

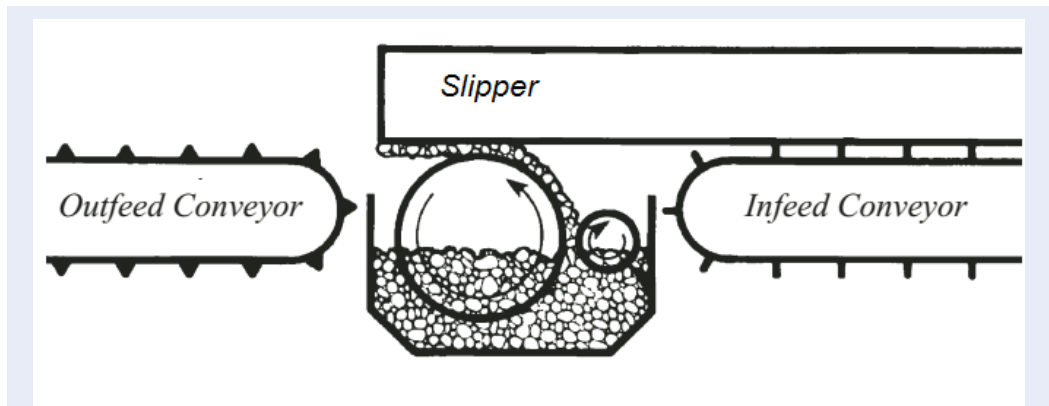

Figure 1: Principle of glue spread on a flat surface.

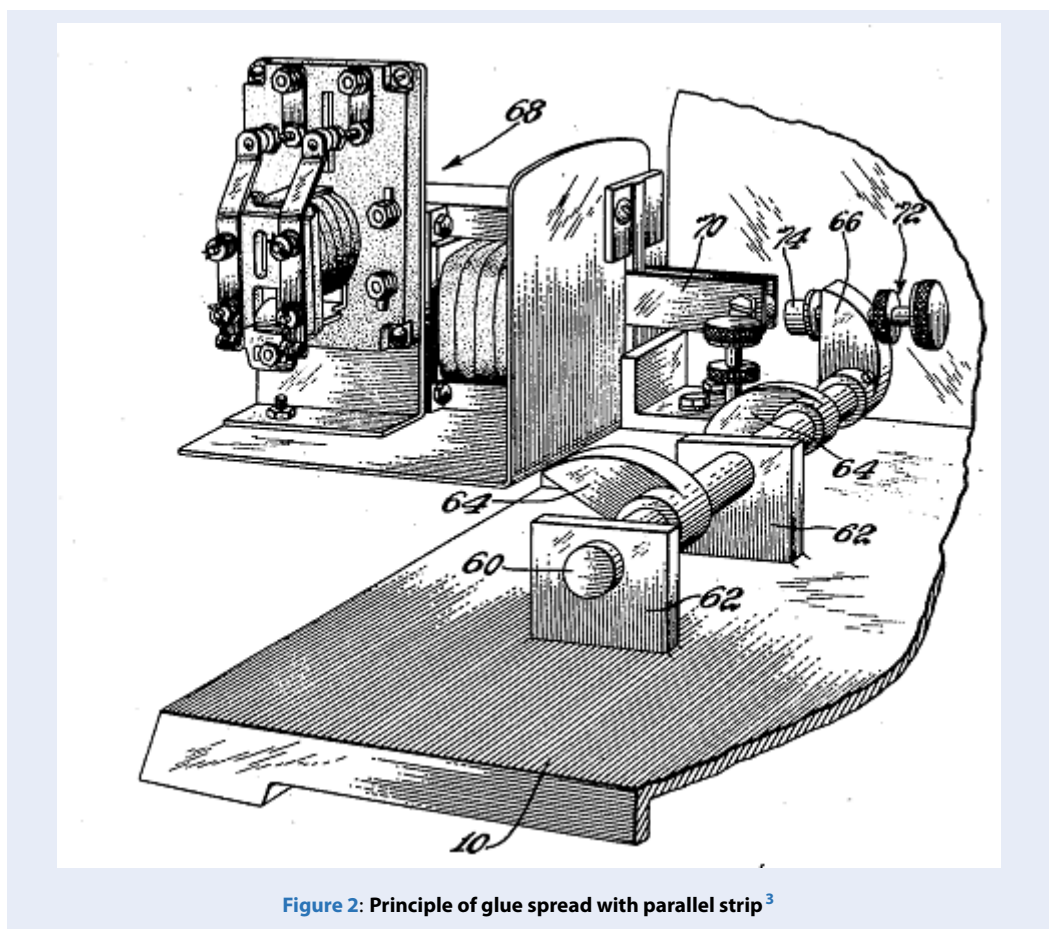

Figure 2: Principle of glue spread with parallel strip<sup>3</sup>

the surface, however, the slot or small hole have not been solved yet. The motor 98 is used to control the valve 88 to adjust the quantity of glue. The parts 103, 104, 102, 108 are linkages to help the motor 98 to rotate the valve 88. The part 76 is plywood. The motor is used to rotate the shaft 82.

With more complicated surfaces, an inventor, Giovanni Viganó, gave a solution that the glue is pumped to the surface and two sides then roller is used to spread the glue on complicated surface<sup>5</sup>. The invention can apply for the very complicated surface but the glue must be used so much and it is not economy as shown in **Figure 4**. The part 6 needing spreading the glue is clamped by 13 and 2. The glue 8 is pumped and over on the part 6. The part 13 is pulled to remove the unnecessary glue.

In this paper, the glue spread will be solved on a complicated surface of a slipper. The surface (**Figure 5**) consist of faces and lines of intersections of these faces. Using roller and spray is inefficient because the glue is difficult to reach the said intersections and spread all of surfaces. The bad result is displayed in **Figure 5**. Thus, a new solution written in this paper is to use rollers with different rotational speed. The roller is supplied enough glue and then slip on the surface to rub the glue on the surface. The roller is covered a kind of material with very low friction.

The next part, principle of the new method of gluing will be showed and then ratio of speed and the regular speed are experimented. The conclusion will summarize the application in reality.

### THEORY OF GLUE SPREAD

The gluing machine consists of rollers. The rollers rotate with opposite direction to make the slipper moves and spreads the glue. The problem for the good result of glue spread is speed of the rollers and the gap between two rollers. The glue with viscosity  $\eta$  and surface velocity  $U_{1,2}$  will determine the quality of glue spread. Viscosity is a term and value used to describe the internal friction of a fluid. A low viscosity product is like water to less force to flow than a high viscosity material, like peanut butter. The low viscosity will make the force required to apply the glue larger. The glue needs a pressure to press glue on the surface of slippers. Following<sup>6-8</sup> the Reynold equation can be written in (1).

$$\frac{\partial}{\partial x} \left( \frac{\rho h^3}{12\eta} \frac{\partial p}{\partial x} \right) + \frac{\partial}{\partial z} \left( \frac{\rho h^3}{12\eta} \frac{\partial p}{\partial z} \right) = -\frac{\partial}{\partial x} \left( \rho \frac{U_1 + U_2}{2} h \right) \quad (1)$$

Where:

$h$  Glue film thickness.

$\eta$  Viscosity

$U_1, U_2$  Velocities of surface.

$\rho$  Density of glue

$x, y, z$  Cartesian Coordinate (**Figure 6**).

$p$  Pressure on the surface.

To ensure the glue to spread on the slippers, the glue film thickness  $h$  must be larger than  $h_c$ . For circular cylinders the film thickness can be written approximately (to a high degree of accuracy for small  $x/R$ ).

$$h = h_c + \frac{x^2}{2R_1} + \frac{x^2}{2R_2} + v_1 + v_2 \quad (2)$$

where:  $v$  is the elastic displacement at point  $x$  in the  $y$  direction, and depends upon  $p$ . It will be noted that in the special case of constant viscosity this condition reduces to  $\frac{d^2 p}{dx^2} = 0$ . When side leakage is neglected Reynolds equation for an incompressible fluid reduces to:

$$\frac{d}{dx} \left( \frac{h^3}{\eta} \frac{dp}{dx} \right) = -12U \frac{dh}{dx} \quad (3)$$

where  $U = \frac{U_1 + U_2}{2}$

On differentiating and rearranging terms Eq. (3) becomes:

$$\frac{h^3}{\eta} \left( \frac{d^2 p}{dx^2} - \frac{1}{\eta} \frac{d\eta}{dx} \frac{dp}{dx} \right) + \frac{dh}{dx} \left( 12U + \frac{3h^2}{\eta} \frac{dp}{dx} \right) = 0 \quad (4)$$

In general, for films bounded by continuous solids, two points can be located on the pressure curve where the following condition is satisfied:

$$\frac{d^2 p}{dx^2} - \frac{1}{\eta} \frac{d\eta}{dx} \frac{dp}{dx} = 0 \quad (5)$$

It will be noted that in the special case of constant viscosity this condition reduces to  $\frac{d^2 p}{dx^2} = 0$ . When the condition represented by Eq. (5) is satisfied, Eq. (4) reduces to:

$$\frac{dh}{dx} \left( 12U + \frac{3h^2}{\eta} \frac{dp}{dx} \right) = 0 \quad (6)$$

Solutions to equation (6) are

$$\begin{cases} \frac{dh}{dx} = 0 \\ \frac{dp}{dx} = -\frac{4\eta U}{h^2} \end{cases} \quad (7)$$

To solve the Eq. (7), we obtain  $h$  and  $p$ . To obtain good values of  $h$  and  $p$ , D. Dowson and G. R. Higginson<sup>6</sup> showed that the pressure  $p$  must be positive at certain value  $h$ . The optimal  $p$  depends on the viscosity of the glue. In<sup>6,7</sup>, The stresses due to a narrow

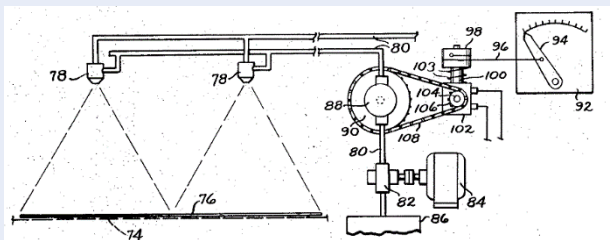

Figure 3: Principle of spraying glue<sup>4</sup>

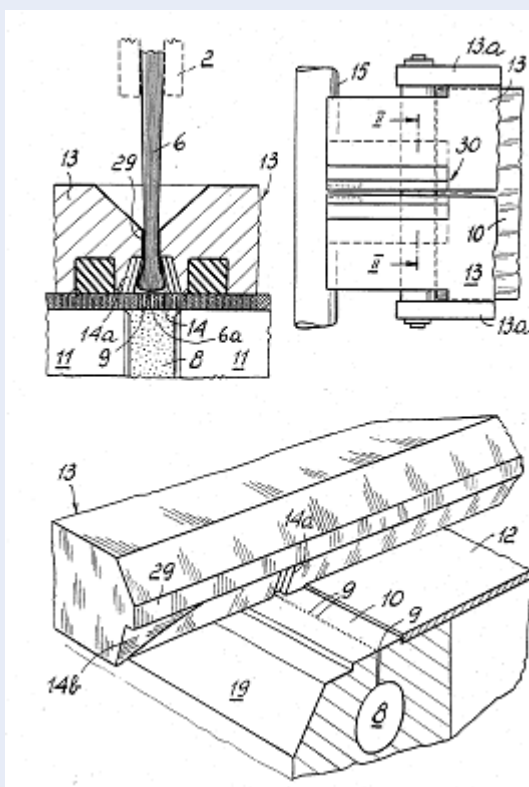

Figure 4: Pump glue and spread glue<sup>5</sup>



Figure 5: The real surface of slipper and result of the glue spread.

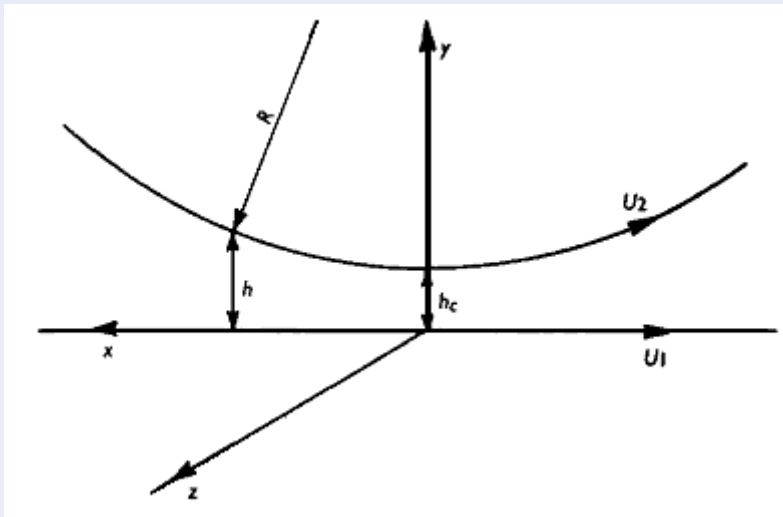

Figure 6: Parameters in the gluing system.

strip of pressure  $p$  over a width  $ds$  in the  $x$  direction are, therefore,

$$\begin{cases} p_x = \frac{\phi x^2 y}{(x^2 + y^2)^2} \\ p_y = \frac{\phi y^3}{(x^2 + y^2)^2} \\ q_{xy} = \frac{\phi xy^2}{(x^2 + y^2)^2} \end{cases} \quad (8)$$

where  $\phi = -2pds/\pi$

With some steps of solving, the Eq. (8) becomes.

$$\begin{cases} p_x = -\frac{2}{\pi} \int_{s_1}^{s_2} \frac{p(x-s)^2 y}{[(x-s)^2 + y^2]^2} ds \\ p_y = -\frac{2}{\pi} \int_{s_1}^{s_2} \frac{py^3}{[(x-s)^2 + y^2]^2} ds \\ q_{xy} = -\frac{2}{\pi} \int_{s_1}^{s_2} \frac{p(x-s)^2 y^2}{[(x-s)^2 + y^2]^2} ds \end{cases} \quad (9)$$

where,  $p = a + b + cs^2, a = 0.3, b = 0.2, c = 0.5^6$ . In the Eq.9, the width of the glue trip is from  $s_1$  to  $s_2$ . The value  $x$  is from 0 to the length of the roller. The value  $y$  is the film thickness in Eq. (2). Thus, all of parameters are determined and the value of stress and the gap are shown in Figure 10, which calculates reasonable stresses so that glue can spread on the slippers.

### EXPERIMENT, DISCUSSION AND RESULTS

The equation of stress will experiment on a model as showed in Figure 7.

The model of glue spread consists of 2 rollers rotating with opposite direction, in figure. One upper roller is made of rubber having a high friction coefficient. It

will pull and keep the slipper. The other made of steel is used to spread the glue. To ensure the thickness of glue on the slipper, a steel roller is beneath used. The gap between two steel rollers will decide the thickness of glue to spread. To increase the efficiency of glue spread, the angle velocity of the rubber roller and the steel one is different and the velocity is controlled by an inverter.

To measure the glue spread, the UV light was used. Where there is glue spread, the glue will reflect the UV light and it is dark where no glue is applied. To control the angular velocity of rollers, the frequency converter is used. The angular velocity of the rollers will change easily and exactly by rotating a knob. The model is designed screws to adjust the stress on the surface of the slipper. The slipper will be tested with 5 different gaps between two rollers. And then velocity will change and the glue spread is recorded.

Figure 7 describes the method to load the glue. The loading roller takes the glue from the container and transfer the glue to next roller and then to bring the glue to the slippers. The rubber roller is used to pull the slippers. The result of experimental data is shown in Figure 8 and Figure 9.

From the experiment data, some results can be written:

- The gap between two rollers will be smaller 10 mm. When the gap is smaller than 10mm, the glue is pressed hardly on the surface of slipper (Figure 10). This situation makes the glue spread over the surface of slipper. The result of spread is illustrated in Figure 10. The gap



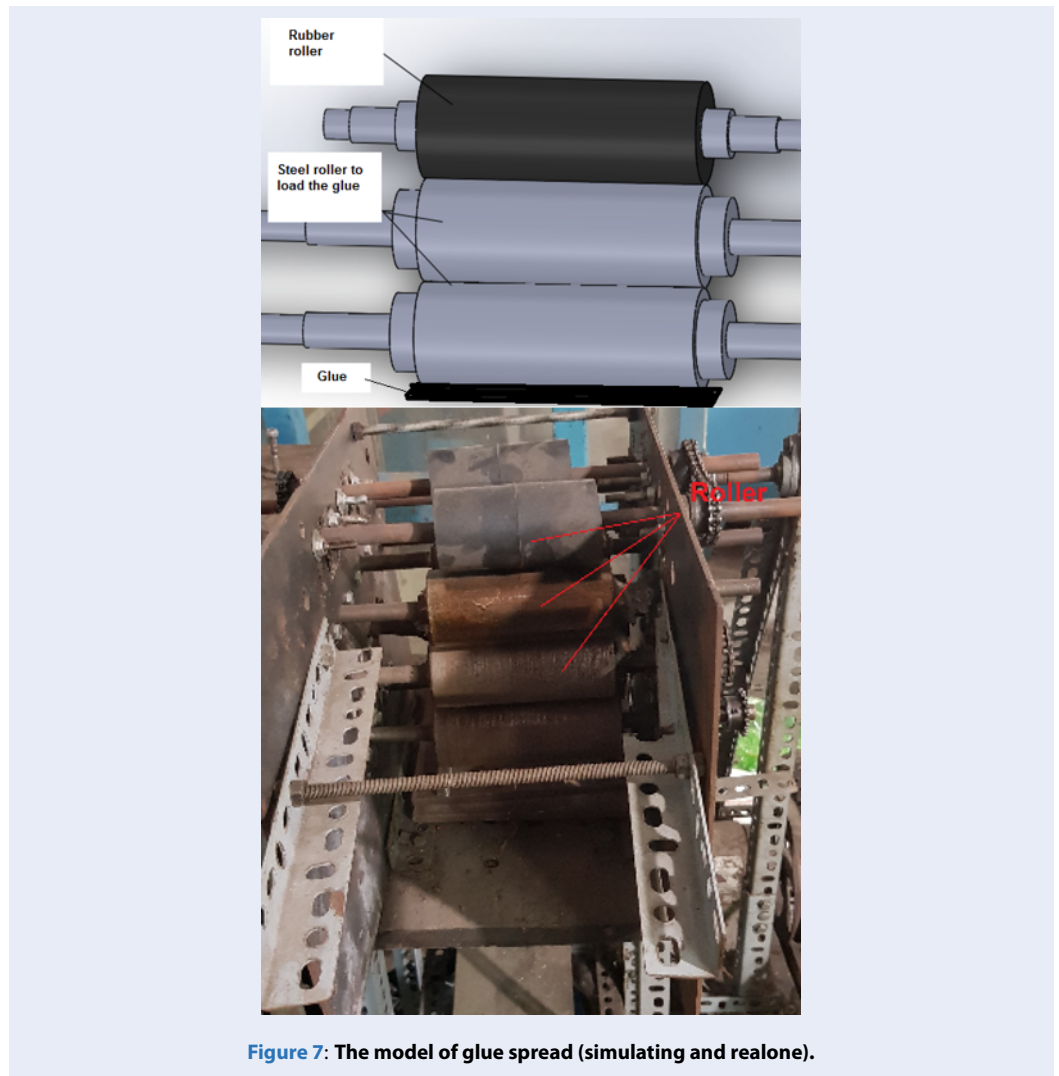

Figure 7: The model of glue spread (simulating and realone).

must not decrease so much because The glue will run to sides of the slipper, which will use so much glue and make the manufacturing cost higher. When the gap is smaller 11 mm, the phenomenon of the glue running to the sides begins.

- The angular velocity should be under a limit speed. When angular velocity increases, the number of slippers per a minute does too, however, the area of glue spread has decreased. The reason is that the viscosity and surface tension prevent the glue to reach all of the area of the slipper with short time, which needs time for glue to attract the surface (\$).
- With 2 kinds of experiment, gap between 2 rollers and glue spread versus angular velocity,

the glue cannot still reach the section between surfaces of the slipper (Figure 12). To solve this problem, the gap between 2 roller is reduced and the result is better, however if the gap is so small, some cracks on the surface of the slipper appear. This problem can explain that the small gap makes the glue film thinner and the glue from the roller cannot reach the section. Thus, the new method needs to improve the glue spread.

### THE NEW METHOD FOR GLUE SPREAD AND BETTER RESULTS

When the gap is reduced, the pressure increases and the glue can apply in the surface of slipper easily. However on the section of surface on the slipper, the glue is very difficult to reach. To enhance the adhe-

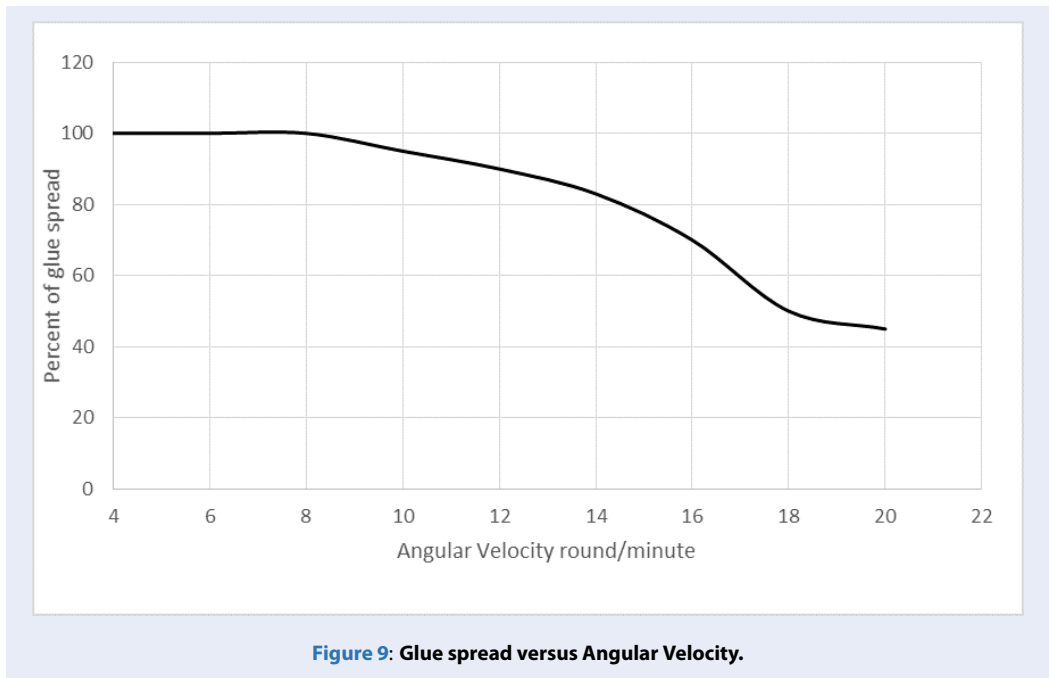
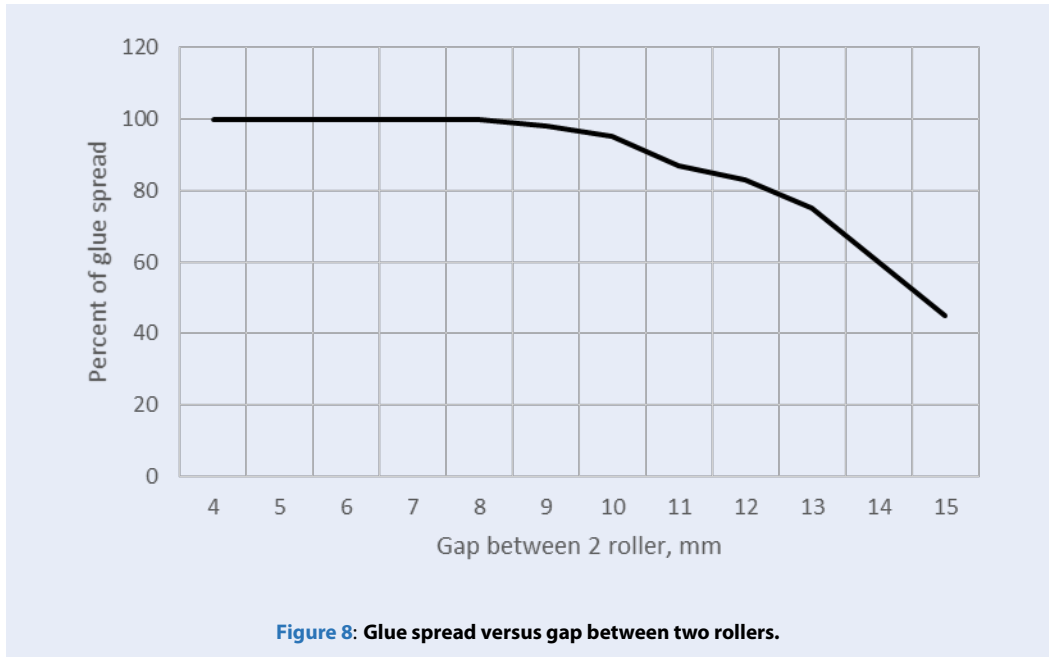

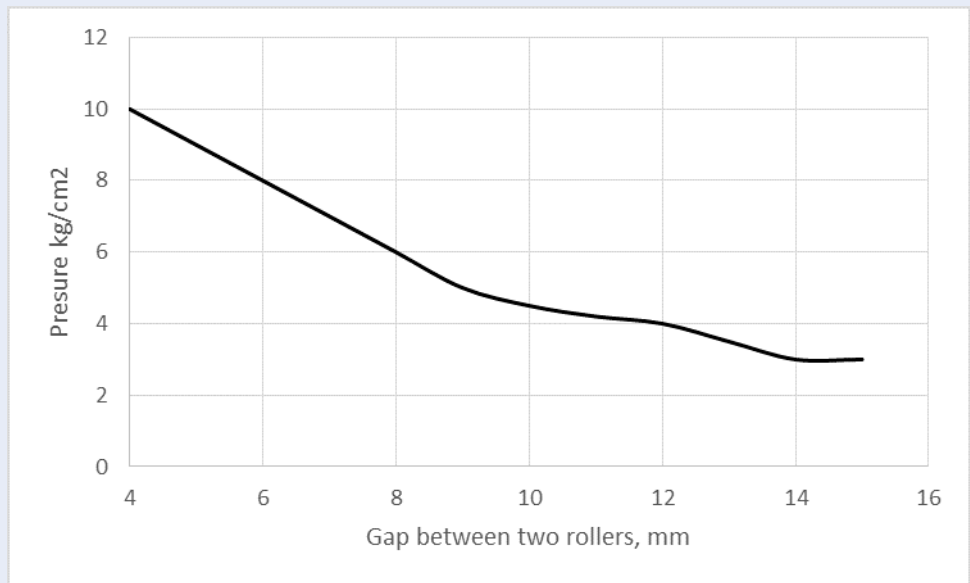

Figure 10: Pressure from Eq. (9) versus the gap.



Figure 11: Glue spread on the slipper.

sive between glue and the surface of slippers, the glue need rubbed on the surface of the slipper. Thus, this part will introduce a new method to increase the rub of glue on the surface. To increase the rub, the slipper should move faster than the roller. To obtain the different velocity between the slipper and the roller, the upper roller is covered thin rubber with high friction coefficient and this roller rotates faster than the other. Because of the high friction coefficient, the upper roller will haul the slipper to go with this one. The question is what the angular velocity ratio between two rollers ensuring the glue spreading is. Experiments will be made to answer the question.

The experiment model is showed in **Figure 7** but another frequency converter is additional used to control the speed of the upper roller. That means each roller is controlled by a frequency converter. From the **Figure 9**, the velocity of the lower roller is kept

8 rounds/minute (~150 centimeter/minute) the other is changed. Result of the experiment is drawn in **Figure 13**.

From the **Figure 13**, the ratio between two rollers should be 1.4 to 1.5. If the ratio increase, the glue film becomes so thin and as a result of that, glue is not enough for spread. If the ratio decreases so much, the efficiency of the rub reduces too.

## CONCLUSIONS

The footwear industry is developing very fast in Vietnam. Thus, automatic machines need to supply to the footwear industry to increase labor productivity and decrease workers. The glue spread machine with two rollers is experimented. It shows that two rollers should rotated with different angle velocity. The ratio between two velocities is about 1.4 to make the good result on glue spread.



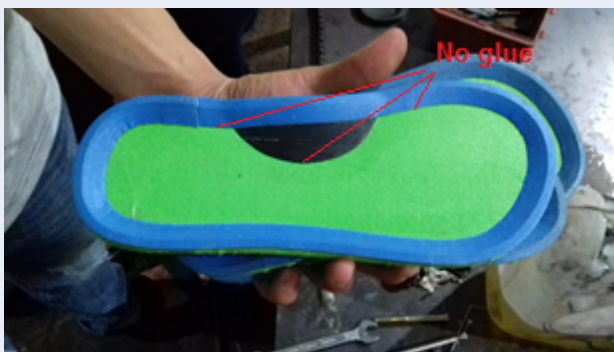

Figure 12: No glue at the intersection.

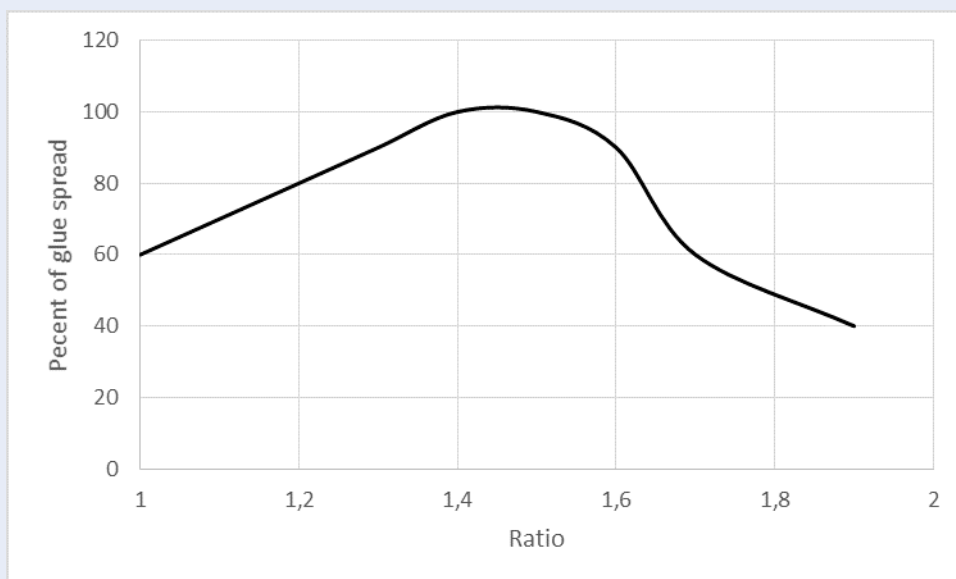

Figure 13: The glue spread versus angular velocity ratio.

### COMPETING INTERESTS

Authors declare no conflict of interests.

### ACKNOWLEDGMENTS

This research is funded by Vietnam National University Ho Chi Minh City (VNU-HCM) under grant number C2018-20-05.

### REFERENCES

1. Taylor JL. Manufacturing, "Glue Application. Glue Mixing;.
2. Petersen EA. Glue Applying Machine. Patent Serial;165(785).
3. Schaefer CF. Glue Applying Machine. Patent Serial;133(564).
4. Steinberg JM. Plywood Manufacture with Controlled Glue Spread. Patent Serial;817(92).
5. Giovanni Viganó, "Device and Method For Spread Applying Liquids, In Particular Glue Over Book Spines". Patent Number;4(512).
6. Higginson DDGR. A Numerical Solution to The Elasto-Hydrodynamic Problem. Journal Mechanical Engineering Science. 1959;1(1).
7. Boness RJ. The Effect of Oil Supply on Cage and Roller Motion in a Lubricated Roller Bearing. Journal of Lubrication Technology. 1970 1;.
8. Dowson D. Elasto-Hydro Dynamic Lubrication. Pergamon Press; 1977.

# Phương pháp mới bôi keo đế dép cao su với bề mặt phức tạp

Lưu Thanh Tùng\*

## TÓM TẮT

Ngày nay, Người ta thường mang giày hoặc dép lê khi đi ra ngoài. Dép lê cao su rất phổ biến trên thế giới, đặc biệt là trong khu du lịch. Dép lê khá phổ biến ở những đất nước nhiệt đới như Việt nam. Một chiếc dép bao gồm nhiều lớp và được dán keo và sau đó ép để đảm bảo chúng không được tách ra trong thời gian sử dụng. Trong quá khứ, các lớp dép được dán bởi các con lăn vì bề mặt các lớp phẳng và đơn giản. Tuy nhiên, dép được cải thiện và sau đó bề mặt của các lớp trở nên phức tạp và khó khăn để quét keo. Những bề mặt này được hình thành do những bề mặt cong tạo ra mà phù hợp với chân con người. Vì vậy, người công nhân phải sử dụng một bàn chải để quét keo trên bề mặt, đặc biệt là các chỗ giao tuyến của các mặt cong. Các con lăn được thử, nhưng kết quả chưa đạt do keo khó có thể đạt đến đường kết nối hai mặt của bề mặt dép. Các chiếc dép không có keo sẽ làm cho một chiếc dép trở nên hư hỏng sau khi sử dụng. Trong bài báo này, mặc dù các con lăn cũng được áp dụng nhưng tốc độ quay của các con lăn này khác nhau. Tốc độ khác nhau giúp keo lan rộng giống như dán keo bằng tay. Số lượng con lăn sẽ được xác định bởi thực nghiệm. Tỷ lệ tốc độ quay cũng được cho thấy bằng thí nghiệm để có được kết quả tốt nhất của sự lan truyền keo. Tất cả các dữ liệu thí nghiệm sẽ được thể hiện dưới dạng đồ thị mà giúp cho người đọc hiểu rõ hơn về các thông số tối ưu cho hoạt động của máy. Kết quả của bào báo là cơ sở để có thể thiết kế máy giúp cho ngành công nghiệp giày phát triển.

**Từ khoá:** Dép xỏ ngón cao su, Quét keo, Tốc độ quay con lăn, Con lăn, Khác tốc

Trường Đại học Bách Khoa,  
ĐHQG-HCM

## Liên hệ

Lưu Thanh Tùng, Trường Đại học Bách  
Khoa, ĐHQG-HCM

Email: ttluu@hcmut.edu.vn

## Lịch sử

- Ngày nhận: 21-6-2018
- Ngày chấp nhận: 02-5-2019
- Ngày đăng: 25-5-2019

## DOI :



## Bản quyền

© ĐHQG Tp.HCM. Đây là bài báo công bố mở được phát hành theo các điều khoản của the Creative Commons Attribution 4.0 International license.



**Trích dẫn bài báo này:** Tùng L.T. Phương pháp mới bôi keo đế dép cao su với bề mặt phức tạp. *Sci. Tech. Dev. J. - Eng. Tech.*; 2(1):1-10.